

Katrin poubelle avec couvercle 50 l

91912

- Les poubelles noires et blanches complètent à merveille la gamme de distributeurs Inclusive.
- Il est inutile de toucher le couvercle.
- Avec support mural en option.



ISO 9001 ISO 14001

Produit



x 420 mm
 y 575 mm
 z 280 mm



Blanc



2,8 kg

Emballage pour le transport

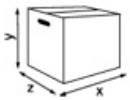

x 425 mm
 y 600 mm
 z 285 mm



2



6,46 kg



VE



6414300091912

Information concernant la palette

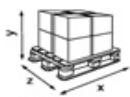

x 800 mm
 y 2550 mm
 z 1200 mm



22



167,42 kg



6414300091936

Dimensions

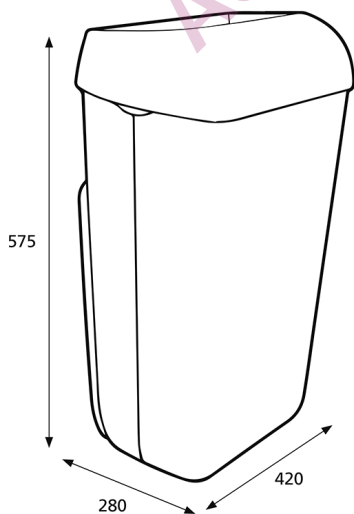

Instructions de montage

